

MS5607-B Micro Altimeter Module

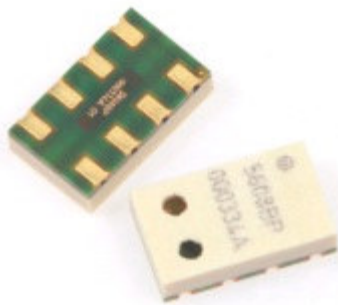

- High resolution module, 20cm
- Fast conversion down to 1 ms
- Low power, 1 μA (standby < 0.15 μA)
- QFN package 5.0 x 3.0 x 1.0 mm³
- Supply voltage 1.8 to 3.6 V
- Integrated digital pressure sensor (24 bit $\Delta\Sigma$ ADC)
- Operating range: 10 to 1200 mbar, -40 to +85 °C
- I²C and SPI interface up to 20 MHz
- No external components (Internal oscillator)
- Excellent long term stability

DESCRIPTION

The MS5607-B is a new generation of high resolution altimeter sensors from MEAS Switzerland with SPI and I²C bus interface. It is optimized for altimeters and variometers with an altitude resolution of 20 cm. The sensor module includes a high linearity pressure sensor and an ultra low power 24 bit $\Delta\Sigma$ ADC with internal factory calibrated coefficients. It provides a precise digital 24 bit pressure and temperature value and different operation modes that allow the user to optimize for conversion speed and current consumption. A high resolution temperature output allows the implementation of an altimeter/thermometer function without any additional sensor. The MS5607-B can be interfaced to virtually any microcontroller. The communication protocol is simple, without the need of programming internal registers in the device. Small dimensions of only 5.0 mm x 3.0 mm and a height of only 1.0 mm allow for integration in mobile devices. This new sensor module generation is based on leading MEMS technology and latest benefits from MEAS Switzerland proven experience and know-how in high volume manufacturing of altimeter modules, which have been widely used for over a decade. The sensing principle employed leads to very low hysteresis and high stability of both pressure and temperature signal.

FEATURES

FIELD OF APPLICATION

- Mobile altimeter / barometer systems
- Bike computers
- Adventure or multi-mode watches
- Variometers
- Dataloggers

TECHNICAL DATA

Sensor Performances (V _{DD} = 3 V)				
Pressure	Min	Typ	Max	Unit
Range	10		1200	mbar
ADC	24			bit
Resolution (1)	0.13 / 0.084 / 0.054 / 0.036 / 0.024			mbar
Accuracy 25°C, 750 mbar	-1.5		+1.5	mbar
Error band, -20°C to +85°C 300 to 1100 mbar (2)	-2.5		+2.5	mbar
Response time (1)	0.5 / 1.1 / 2.1 / 4.1 / 8.22			ms
Long term stability		-1		mbar/yr
Temperature	Min	Typ	Max	Unit
Range	-40		+85	°C
Resolution	<0.01			°C
Accuracy	-0.8		+0.8	°C
Notes: (1) Oversampling Ratio: 256 / 512 / 1024 / 2048 / 4096 (2) With autozero at one pressure point				

FUNCTIONAL BLOCK DIAGRAM

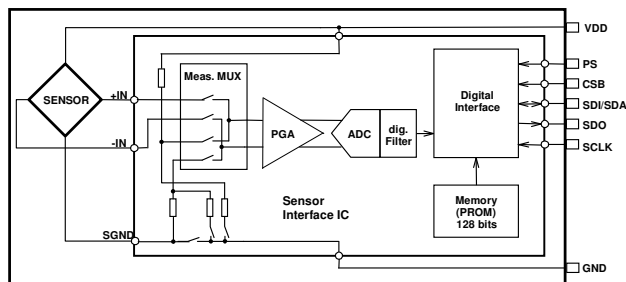

MS5607-B Micro Altimeter Module

PERFORMANCE SPECIFICATIONS

ABSOLUTE MAXIMUM RATINGS

Parameter	Symbol	Conditions	Min.	Typ.	Max	Unit
Supply voltage	V _{DD}		-0.3		+4.0	V
Storage temperature	T _S		-40		+125	°C
Overpressure	P _{max}				6	bar
Maximum Soldering Temperature	T _{max}	40 sec max			250	°C
ESD rating		Human Body Model	-4		+4	kV
Latch up		JEDEC standard No 78	-100		+100	mA

ELECTRICAL CHARACTERISTICS

Parameter	Symbol	Conditions	Min.	Typ.	Max	Unit
Operating Supply voltage	V _{DD}		1.8	3.0	3.6	V
Operating Temperature	T		-40	+25	+85	°C
Supply current (1 sample per sec.)	I _{DD}	OSR 4096		12.5		μA
		2048		6.3		
		1024		3.2		
		512		1.7		
		256		0.9		
Peak supply current		during conversion		1.4		mA
Standby supply current		at 25 °C		0.02	0.14	μA
VDD Capacitor		From VDD to GND	100			nF

ANALOG DIGITAL CONVERTER (ADC)

Parameter	Symbol	Conditions	Min.	Typ.	Max	Unit
Output Word				24		bit
Conversion time	t _c	OSR 4096	7.40	8.22	9.04	ms
		2048	3.72	4.13	4.54	
		1024	1.88	2.08	2.28	
		512	0.95	1.06	1.17	
		256	0.48	0.54	0.60	

MS5607-B Micro Altimeter Module

PERFORMANCE SPECIFICATIONS (CONTINUED)

PRESSURE OUTPUT CHARACTERISTICS ($V_{DD} = 3\text{ V}$, $T = 25\text{ °C}$ UNLESS OTHERWISE NOTED)

Parameter	Conditions	Min.	Typ.	Max	Unit
Operating Pressure Range	P_{range} Full Accuracy	300		1100	mbar
Extended Pressure Range	P_{ext} Linear Range of ADC	10		1200	mbar
Total Error band, no autozero	at 25°C, 700..1100 mbar	-1.5		+1.5	mbar
	at 0..50°C, 300..1100 mbar	-2.0		+2.0	
	at -20..85°C, 300..1100 mbar	-3.5		+3.5	
	at -40..85°C, 300..1100 mbar	-6.0		+6.0	
Total Error band, autozero at one pressure point	at 25°C, 700..1100 mbar	-0.5		+0.5	mbar
	at 0..50°C, 300..1100 mbar	-1.0		+1.0	
	at -20..85°C, 300..1100 mbar	-2.5		+2.5	
	at -40..85°C, 300..1100 mbar	-5.0		+5.0	
Maximum error with supply voltage	$V_{DD} = 1.8\text{ V} \dots 3.6\text{ V}$	-2.5		+2.5	mbar
Resolution RMS	OSR	4096	0.024		mbar
		2048	0.036		
		1024	0.054		
		512	0.084		
		256	0.130		
Long-term stability			-1		mbar/yr
Reflow soldering impact	IPC/JEDEC J-STD-020C (See application note AN808)		+0.4		mbar
Recovering time after reflow (1)			7		days

(1) Time to recovering at least 66% of the reflow impact

TEMPERATURE OUTPUT CHARACTERISTICS ($V_{DD} = 3\text{ V}$, $T = 25\text{ °C}$ UNLESS OTHERWISE NOTED)

Parameter	Conditions	Min.	Typ.	Max	Unit
Absolute Accuracy	at 25°C	-0.8		+0.8	°C
	-20..85°C	-2.0		+2.0	
	-40..85°C	-4.0		+4.0	
Maximum error with supply voltage	$V_{DD} = 1.8\text{ V} \dots 3.6\text{ V}$	-0.5		+0.5	°C
Resolution RMS	OSR	4096	0.002		°C
		2048	0.003		
		1024	0.005		
		512	0.008		
		256	0.012		

MS5607-B Micro Altimeter Module

PERFORMANCE SPECIFICATIONS (CONTINUED)

DIGITAL INPUTS (CSB, I²C, DIN, SCLK)

Parameter	Symbol	Conditions	Min.	Typ.	Max	Unit
Serial data clock	SCLK	SPI protocol			20	MHz
Input high voltage	V _{IH}	Pins CSB	80% V _{DD}		100% V _{DD}	V
Input low voltage	V _{IL}		0% V _{DD}		20% V _{DD}	V
Input leakage current	I _{leak25°C} I _{leak85°C}	at 25 °C			0.15	μA
Input capacitance	C _{IN}				6	pF

PRESSURE OUTPUTS (I²C, DOUT)

Parameter	Symbol	Conditions	Min.	Typ.	Max	Unit
Output high voltage	V _{OH}	I _{source} = 1.0 mA	80% V _{DD}		100% V _{DD}	V
Output low voltage	V _{OL}	I _{sink} = 1.0 mA	0% V _{DD}		20% V _{DD}	V
Load capacitance	C _{LOAD}				16	pF

MS5607-B Micro Altimeter Module

FUNCTIONAL DESCRIPTION

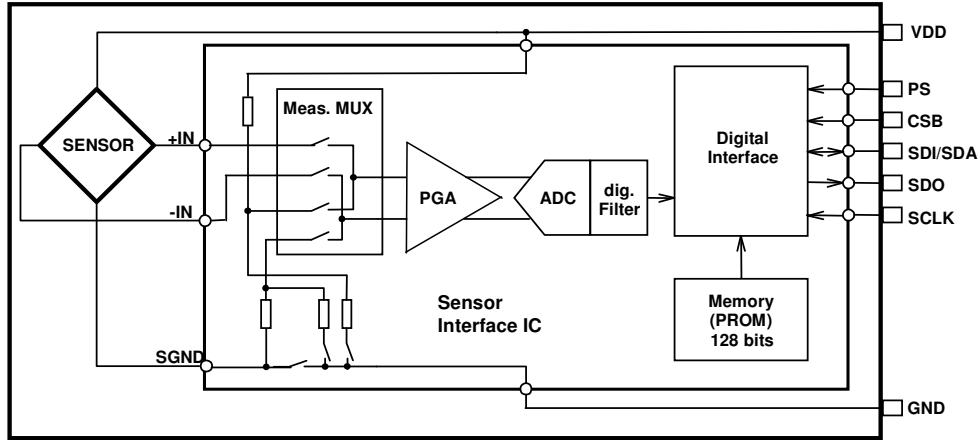

Figure 1: Block diagram of MS5607-B

GENERAL

The MS5607-B consists of a piezo-resistive sensor and a sensor interface IC. The main function of the MS5607-B is to convert the uncompensated analogue output voltage from the piezo-resistive pressure sensor to a 24-bit digital value, as well as providing a 24-bit digital value for the temperature of the sensor.

FACTORY CALIBRATION

Every module is individually factory calibrated at two temperatures and two pressures. As a result, 6 coefficients necessary to compensate for process variations and temperature variations are calculated and stored in the 128-bit PROM of each module. These bits (partitioned into 6 coefficients) must be read by the microcontroller software and used in the program converting D1 and D2 into compensated pressure and temperature values.

SERIAL INTERFACE

The MS5607-B has built in two types of serial interfaces: SPI and I²C. Pulling the Protocol Select pin PS to low selects the SPI protocol, pulling PS to high activates the I²C bus protocol.

Pin PS	Mode	Pins used
High	I ² C	SDA
Low	SPI	SDI, SDO, CSB

SPI MODE

The external microcontroller clocks in the data through the input SCLK (Serial CLock) and SDI (Serial Data In). In the SPI mode module can accept both mode 0 and mode 3 for the clock polarity and phase. The sensor responds on the output SDO (Serial Data Out). The pin CSB (Chip Select) is used to enable/disable the interface, so that other devices can talk on the same SPI bus. The CSB pin can be pulled high after the command is sent or after the end of the command execution (for example end of conversion). The best noise performance from the module is obtained when the SPI bus is quiet and without communication to other devices during the ADC conversion in progress.

MS5607-B Micro Altimeter Module

I²C MODE

The external microcontroller clocks in the data through the input SCLK (Serial CLock) and SDA (Serial DAta). The sensor responds on the same pin SDA which is bidirectional for the I²C bus interface. So this interface type uses only 2 signal lines and does not require a chip select, which can be favourable to reduce board space. In I²C-Mode the complement of the pin CSB (Chip Select) represents the LSB of the I²C address. It is possible to use two sensors with two different addresses on the I²C bus. The pin CSB shall be connected to VDD or GND (do not leave unconnected!).

COMMANDS

The MS5607-B has only five basic commands:

1. Reset
2. Read PROM (128 bit of calibration words)
3. D1 conversion
4. D2 conversion
5. Read ADC result (24 bit pressure / temperature)

MS5607-B Micro Altimeter Module

PRESSURE AND TEMPERATURE CALCULATION

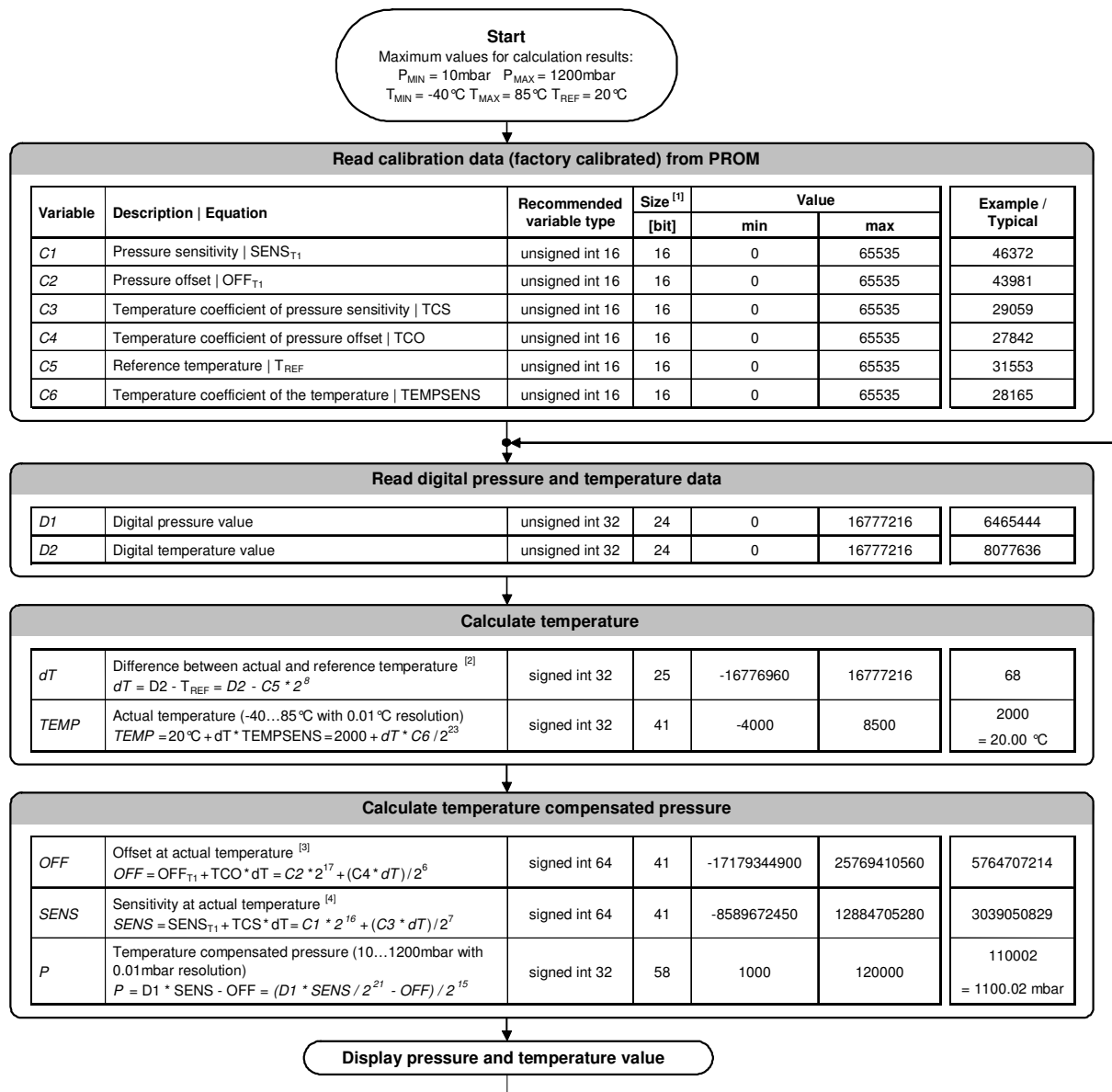

- Notes
- [1] Maximal size of intermediate result during evaluation of variable
 - [2] min and max have to be defined
 - [3] min and max have to be defined
 - [4] min and max have to be defined

Figure 2: Flow chart for pressure and temperature reading and software compensation.

MS5607-B Micro Altimeter Module

SECOND ORDER TEMPERATURE COMPENSATION

In order to obtain best accuracy over temperature range, particularly in low temperature, it is recommended to compensate the non-linearity over the temperature. This can be achieved by correcting the calculated temperature, offset and sensitivity by a second order correction factor and will be recalculated with the standard calculation. The second-order factors are calculated as follows:

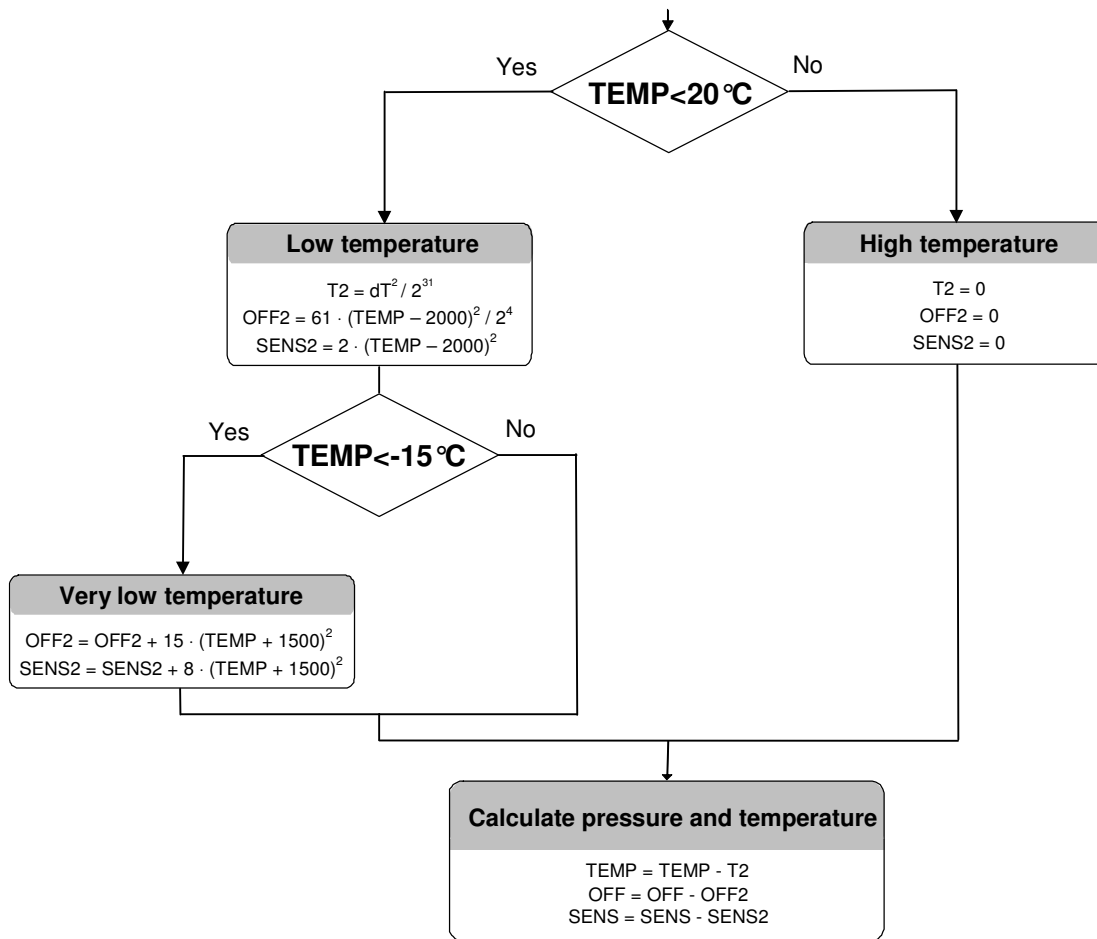

Figure 3: Flow chart for pressure and temperature to the optimum accuracy.

MS5607-B Micro Altimeter Module

SPI INTERFACE

COMMANDS

Size of each command is 1 byte (8 bits) as described in the table below. After ADC read commands the device will return 24 bit result and after the PROM read 16bit result. The address of the PROM is embedded inside of the PROM read command using the a2, a1 and a0 bits.

Bit number	Command byte								hex value
	0	1	2	3	4	5	6	7	
Bit name	PR M	COV	-	Typ	Ad2/ Os2	Ad1/ Os1	Ad0/ Os0	Stop	
Command									
Reset	0	0	0	1	1	1	1	0	0x1E
Convert D1 (OSR=256)	0	1	0	0	0	0	0	0	0x40
Convert D1 (OSR=512)	0	1	0	0	0	0	1	0	0x42
Convert D1 (OSR=1024)	0	1	0	0	0	1	0	0	0x44
Convert D1 (OSR=2048)	0	1	0	0	0	1	1	0	0x46
Convert D1 (OSR=4096)	0	1	0	0	1	0	0	0	0x48
Convert D2 (OSR=256)	0	1	0	1	0	0	0	0	0x50
Convert D2 (OSR=512)	0	1	0	1	0	0	1	0	0x52
Convert D2 (OSR=1024)	0	1	0	1	0	1	0	0	0x54
Convert D2 (OSR=2048)	0	1	0	1	0	1	1	0	0x56
Convert D2 (OSR=4096)	0	1	0	1	1	0	0	0	0x58
ADC Read	0	0	0	0	0	0	0	0	0x00
PROM Read	1	0	1	0	Ad2	Ad1	Ad0	0	0xA0 to 0xAE

Figure 4: Command structure

RESET SEQUENCE

The Reset sequence shall be sent once after power-on to make sure that the calibration PROM gets loaded into the internal register. It can be also used to reset the device ROM from an unknown condition

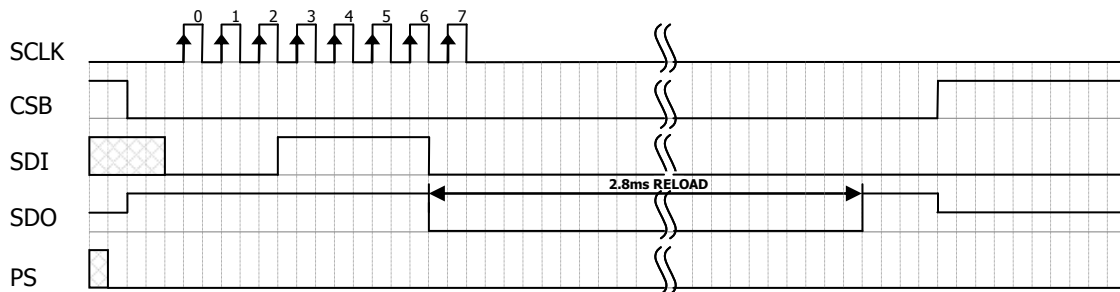

Figure 5: Reset command sequence SPI mode 0

MS5607-B Micro Altimeter Module

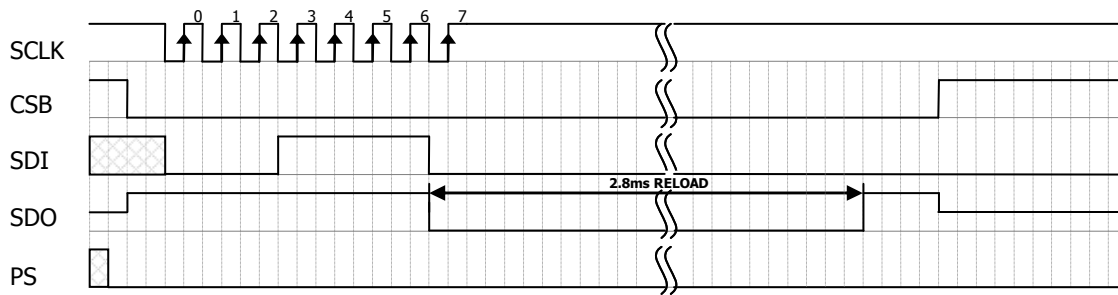

Figure 6: Reset command sequence SPI mode 3

CONVERSION SEQUENCE

The conversion command is used to initiate uncompensated pressure (D1) or uncompensated temperature (D2) conversion. The chip select can be disabled during this time to communicate with other devices. After the conversion, using ADC read command the result is clocked out with the MSB first. If the conversion is not executed before the ADC read command, or the ADC read command is repeated, it will give 0 as the output result. If the ADC read command is sent during conversion the result will be 0, the conversion will not stop and the final result will be wrong. Conversion sequence sent during the already started conversion process will yield incorrect result as well.

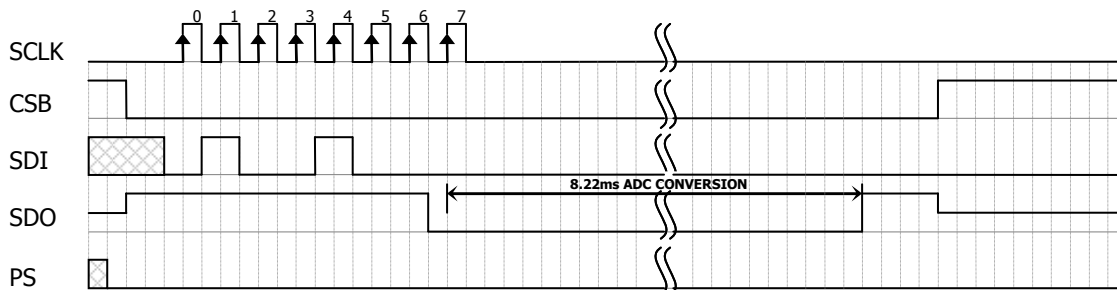

Figure 7: Conversion out sequence, Typ=d1, OSR = 4096

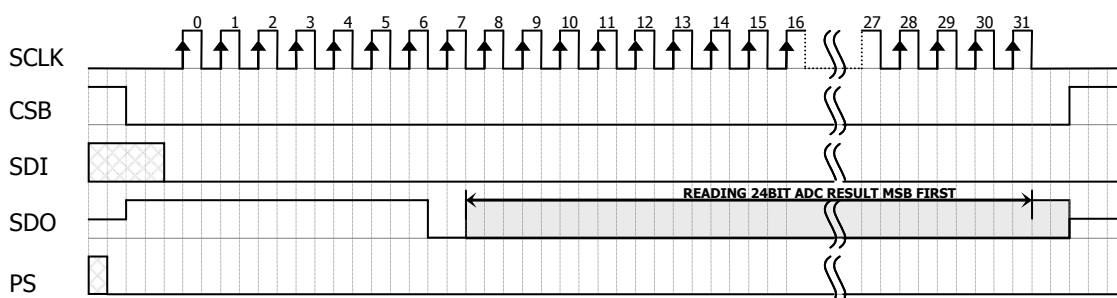

Figure 8: ADC Read sequence

PROM READ SEQUENCE

The read command for PROM shall be executed once after reset by the user to read the content of the calibration PROM and to calculate the calibration coefficients. There are in total 8 addresses resulting in a total memory of 128 bit. Address 0 contains factory data and the setup, addresses 1-6 calibration coefficients and address 7 contains the serial code and CRC. The command sequence is 8 bits long with a 16 bit result which is clocked with the MSB first.

MS5607-B Micro Altimeter Module

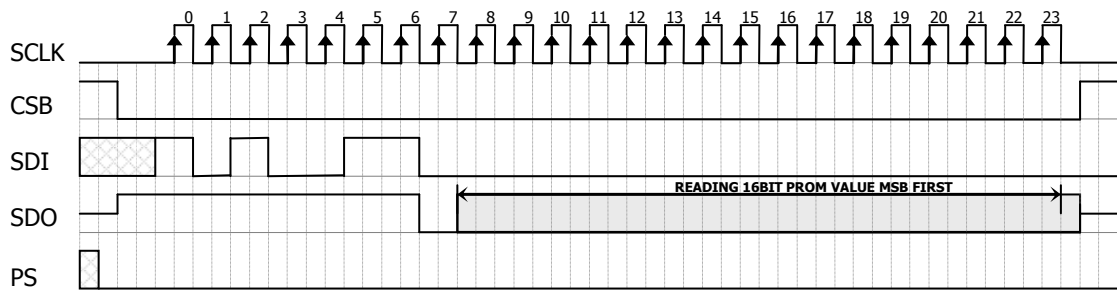

Figure 9: PROM Read sequence, address = 011 (Coefficient 3).

I²C INTERFACE

COMMANDS

Each I²C communication message starts with the start condition and it is ended with the stop condition. The MS5607-B address is 111011Cx, where C is the complementary value of the pin CSB. Since the IC does not have a microcontroller inside, the commands for I²C and SPI are quite similar.

RESET SEQUENCE

The reset can be sent at any time except when the power on did not work it could be possible that the acknowledge blocks the SDA. When SDA is blocked by an undefined state the only way to get the MS5607-B to work is to send a power on reset.

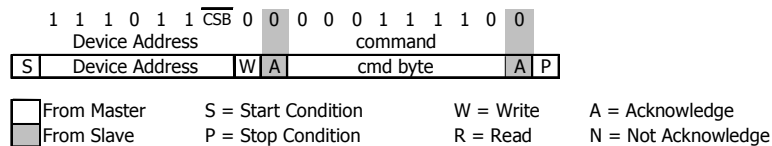

Figure 10: I²C Reset Command

PROM READ SEQUENCE

The PROM Read command consists of two parts. First command sets up the system into PROM read mode. The second part gets the data from the system.

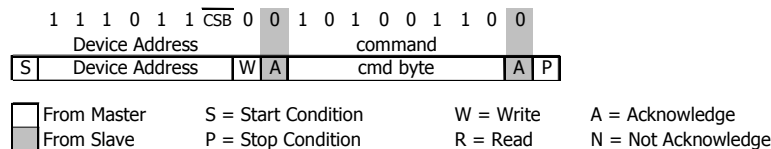

Figure 11: I²C Command to read memory address= 011 (Coefficient 3)

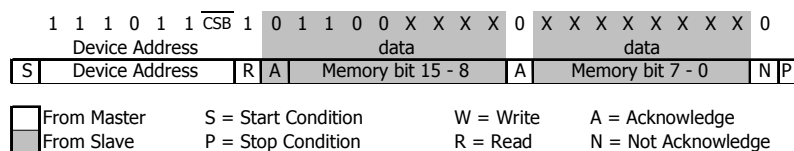

Figure 12: I²C answer from MS5607-B

MS5607-B Micro Altimeter Module

CONVERSION SEQUENCE

A conversion can be started by sending the command to MS5607-B. When command is sent to the system it stays busy until conversion is done. When conversion is finished the data can be accessed by sending a Read command, when an acknowledge appears from the MS5607-B, you may then send 24 SCLK cycles to get all result bits. Every 8 bit the system waits for an acknowledge signal.

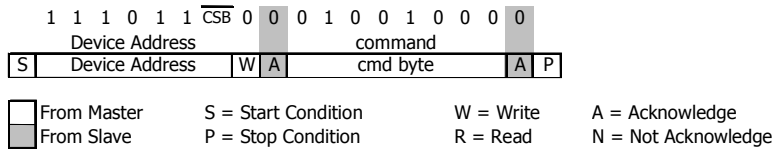

Figure 13: I²C Command to initiate a pressure conversion (OSR=4096, typ=D1)

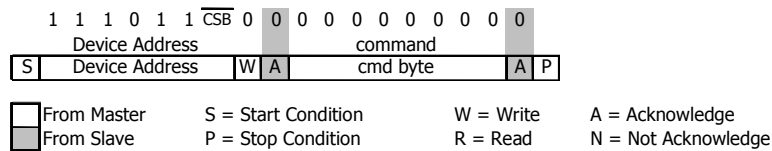

Figure 14: I²C ADC read sequence

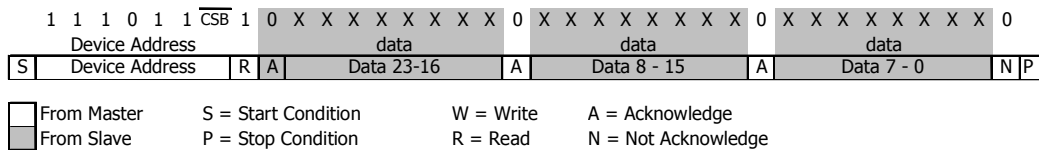

Figure 15: I²C answer from MS5607-B

CYCLIC REDUNDANCY CHECK (CRC)

MS5607-B contains a PROM memory with 128-Bit. A 4-bit CRC has been implemented to check the data validity in memory. The application note AN521 describes in detail CRC-4 code used.

A	D	D	D	D	D	D	D	D	D	D	D	D	D	D	D	D	D
d	B	B	B	B	B	B	B	B	B	B	B	B	B	B	B	B	B
d	1	1	1	1	1	1	9	8	7	6	5	4	3	2	1	0	
0	16 bit reserved for manufacturer																
1	Coefficient 1 (16 bit unsigned)																
2	Coefficient 2 (16 bit unsigned)																
3	Coefficient 3 (16 bit unsigned)																
4	Coefficient 4 (16 bit unsigned)																
5	Coefficient 5 (16 bit unsigned)																
6	Coefficient 6 (16 bit unsigned)																
7																	CRC

Figure 16: Memory PROM mapping

MS5607-B Micro Altimeter Module

APPLICATION CIRCUIT

The MS5607-B is a circuit that can be used in conjunction with a microcontroller in mobile altimeter applications. It is designed for low-voltage systems with a supply voltage of 3 V.

SPI protocol communication

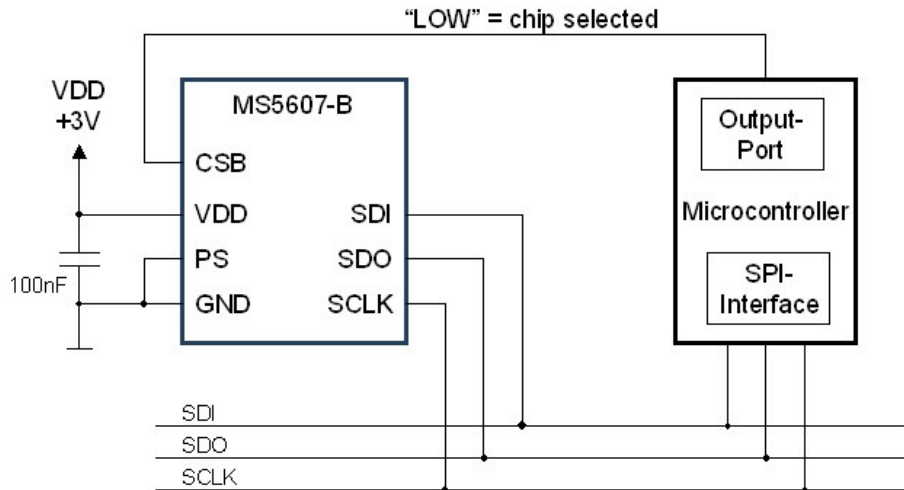

I²C protocol communication

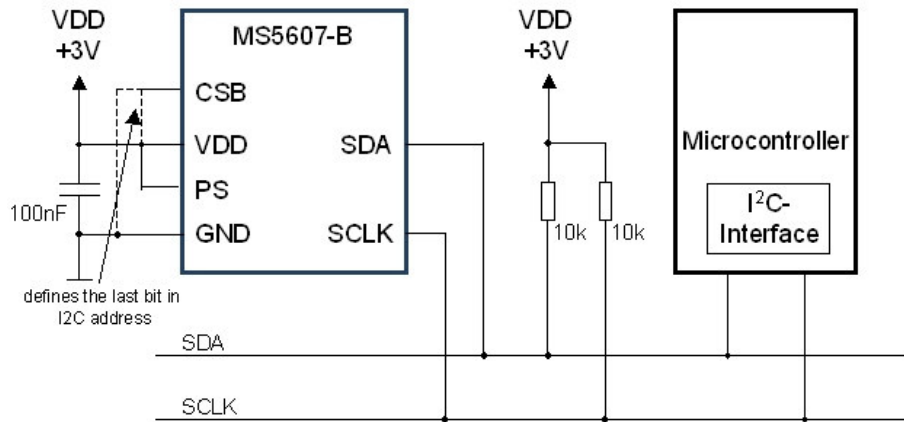
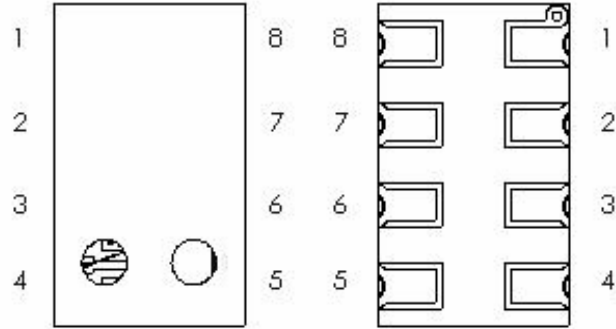

Figure 17: Typical application circuit with SPI / I²C protocol communication

MS5607-B Micro Altimeter Module

PIN CONFIGURATION

Pin	Name	Type	Function
1	VDD	P	Positive supply voltage
2	PS	I	Protocol select PS high (VDD) → I ² C PS low (GND) → SPI
3	GND	G	Ground
4	CSB	I	Chip select (active low), internal connection
5			
6	SDO	O	Serial data output
7	SDI / SDA	I / IO	Serial data input / I ² C data IO
8	SCLK	I	Serial data clock



DEVICE PACKAGE OUTLINE

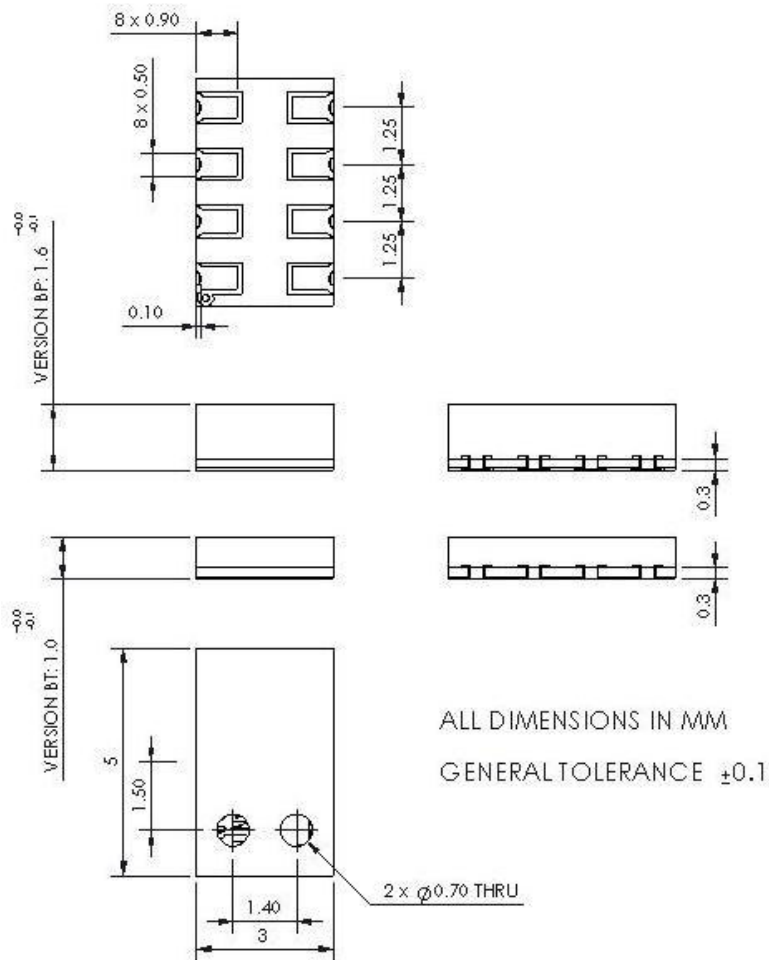

Figure 18: MS5607 package outline

MS5607-B Micro Altimeter Module

MOUNTING AND ASSEMBLY CONSIDERATIONS

SOLDERING

Please refer to the application note AN808 available on our website for all soldering issues.

MOUNTING

The MS5607-B can be placed with automatic Pick & Place equipment using vacuum nozzles. It will not be damaged by the vacuum. Due to the low stress assembly the sensor does not show pressure hysteresis effects. It is important to solder all contact pads.

CONNECTION TO PCB

The package outline of the module allows the use of a flexible PCB for interconnection. This can be important for applications in watches and other special devices.

CLEANING

The MS5607-B has been manufactured under cleanroom conditions. It is therefore recommended to assemble the sensor under class 10'000 or better conditions. Should this not be possible, it is recommended to protect the sensor opening during assembly from entering particles and dust. To avoid cleaning of the PCB, solder paste of type "no-clean" shall be used. Cleaning might damage the sensor!

ESD PRECAUTIONS

The electrical contact pads are protected against ESD up to 4 kV HBM (human body model). It is therefore essential to ground machines and personnel properly during assembly and handling of the device. The MS5607-B is shipped in antistatic transport boxes. Any test adapters or production transport boxes used during the assembly of the sensor shall be of an equivalent antistatic material.

DECOUPLING CAPACITOR

Particular care must be taken when connecting the device to the power supply. A 100 nF ceramic capacitor must be placed as close as possible to the MS5607-B VDD pin. This capacitor will stabilize the power supply during data conversion and thus, provide the highest possible accuracy.

MS5607-B Micro Altimeter Module

TYPICAL PERFORMANCE CHARACTERISTICS

Absolute Pressure Accuracy, 2nd order compensation

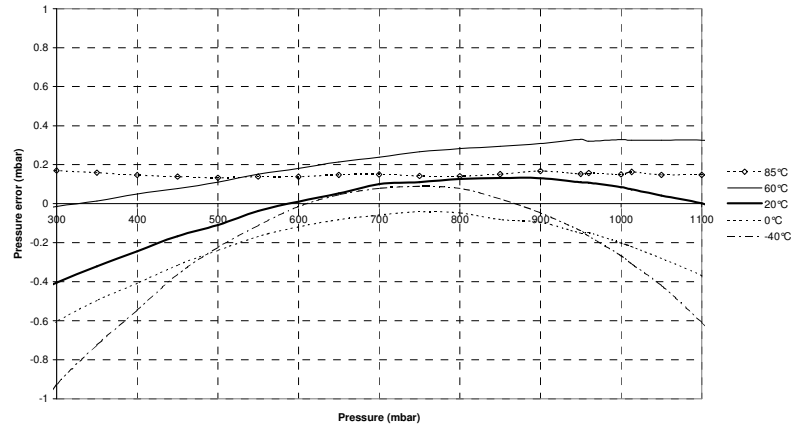

Pressure Error Accuracy vs temperature

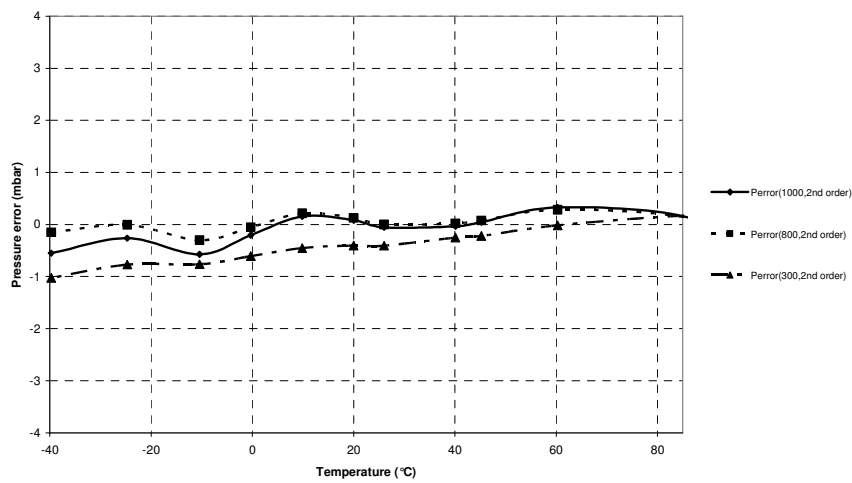

Temperature Error Accuracy vs temperature

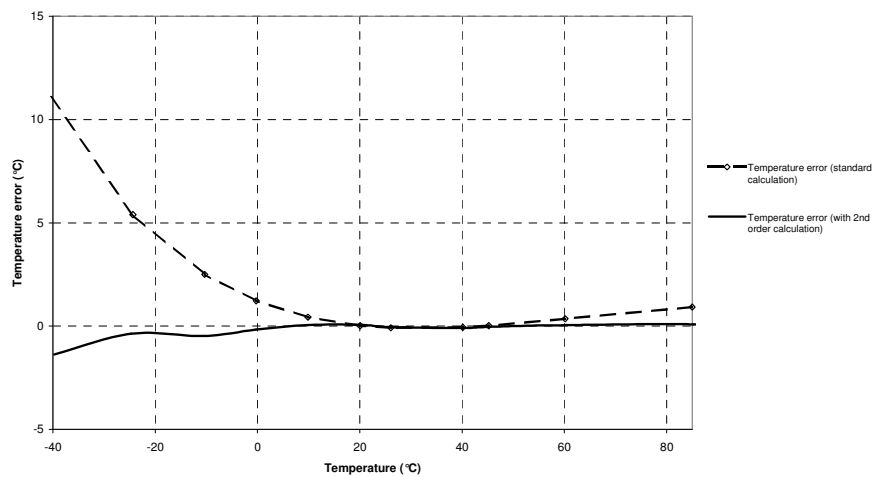

MS5607-B Micro Altimeter Module

TYPICAL PERFORMANCE CHARACTERISTICS (CONTINUED)

Pressure error vs supply voltage (typical)

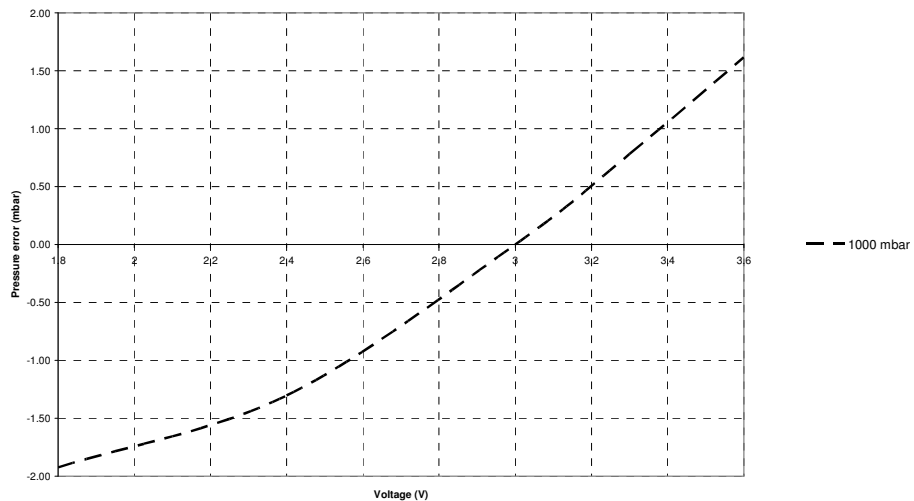

Temperature error vs supply voltage (typical)

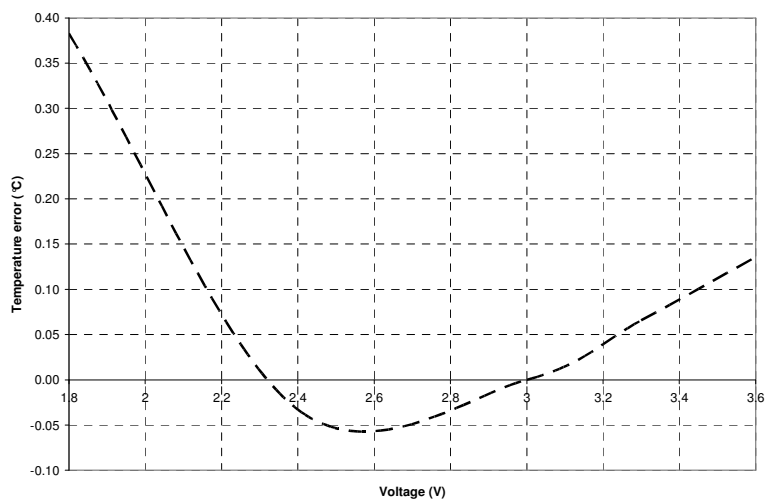

MS5607-B Micro Altimeter Module

ORDERING INFORMATION

Product Code	Product	Art. No
MS5607-BP	Micro Altimeter Module Plastic Cap	325607001
MS5607-BT	Micro Altimeter Module Thin Plastic Cap	325607002